

DSN



COMPACT AND WATERTIGHT DECONTACTOR™ GRP



20 A/32 A/63 A

- ▶ Automatic IP66/IP67/IP69
- ▶ AC-22 and ac-23 breaking capacity
- ▶ Chemical resistant GRP UL 94 casing
- ▶ Impact resistance IK08, vibration resistance
- ▶ -40 °C +60 °C temperature
- ▶ With safety shutter, up to 4 auxiliaries/pilots

TECHNICAL FEATURES

Plugs and sockets with integral load-break switching capability complying with IEC/EN 60309-1 and IEC/EN 60309-4 standards.

	DSN1	DSN3	DSN6
Rated current (In)	20 A	32 A	63 A
U _{max}	500 V	690 V	1 000 V
Power kW AC-22/AC-23	10 kW	15 kW	30 kW
AC-22 switching capability	20 A/500 V	32 A/690 V	50 A/690 V
AC-23 switching capability	20 A/400 V	32 A/400 V	63 A/400 V
Auxiliary contacts (optional)	2 pil	2 aux	4 aux
Keying positions	<<< 24 >>>		
Ambient temperature	<<< -40°C to +60°C >>>		
Short-circuit current I _{cc}	<<< 10 kA >>>		

MOUNTING: LOAD BREAK RELEASE BUTTON SHOULD BE AT THE TOP



IP66/IP67/IP69 WATER- AND DUST-TIGHT



DSN DECONTACTOR™ complies with (download our certificates on marechal.com):

- IEC/EN 60309-1 et IEC/EN 60309-4 European and International standards (plugs and socket-outlets for industrial purposes),
- The European Low Voltage Directive 2014/35/UE, conformity with the CE marking,
- The European 'Machine Directive' 2006/42/CE regarding equipment isolation,
- The French NF C 15-100 standard,
- The French decree dated 20 December 2011 pertaining to the wiring and operating conditions of movable electrical apparatuses,
- The decrees relating to workers' protection in Belgium, Spain and Italy,
- The switch utilization categories AC-22 A and AC-23 A described in IEC/EN 60947-3,
- The UL 1682 and 2682 (USA) and CSA C22.2 N° 182.1-07 (Canada) standards for plugs and socket-outlets.

Also certified by VERITAS LCIE, UL, AS, VDE, TR CU (GOST) and cCSAus and Specification of Military Naval Standard MIL-S-901D (French, American, Australian, German, Russian and Canadian inspection laboratories), and by BUREAU VERITAS MARINE.



WALL MOUNTING SOCKET DSN1



Wall box poly 30°
511B3M20

Socket-outlet
6114017

PLUG DSN1



Straight handle poly
511P0D18

Inlet
6118017

MAIN FEATURES

Rated current (with wiring according to standard)	20 A	Ambient temperature	-40 °C to +60 °C
Maximum voltage	500 V	Flexible wiring (min-max)	1-2,5 mm ²
IP protection lid closed	IP66/IP67/IP69	Stranded wiring (min-max)	1,5-4 mm ²
IP protection plug connected	IP66/IP67/IP69	Other wiring	on request
Shock resistance	IK08	Keying positions	24

LOAD-BREAK CAPABILITY OF THE DECONTACTOR™

Comply with IEC/EN 60309-1 and IEC/EN 60309-4 standards	20 A/500 V
Load-break capability according to IEC/EN 60947-3/AC-22 A	20 A/500 V
Load-break capability according to IEC/EN 60947-3/AC-23 A	20 A/400 V
Short-circuit current I _{cc}	10 kA
Power kW AC-22/AC-23	10 kW

SOCKET-OUTLET female DSN1 (20 A)



INLET male DSN1 (20 A)



Dual-voltage socket-outlet (see p. 7)

20-24 V AC	2P	611408A	611808A
220-250 V AC	1P+N+E	6114015	6118015
380-440 V AC	3P+E	6114013	6118013
220-250 V AC 380-440 V AC	3P+N+E	6114017	6118017
480-500 V AC	3P+E	6114093	6118093
480-500 V AC	3P+N+E	6114097	6118097
Pilots 2 A/250 V AC	+ 2 pilots	Ref. + 972	NA

► Other voltages, frequencies and contact configurations are available (see page 10).



For a black colour GRP housing replace the second reference character 1 with 5.

INFO+

OPTIONS AND ACCESSORIES

Find the boxes, sleeves and handles at the end of the section page 34.





WALL MOUNTING SOCKET DSN³



Wall box poly 30°
512B3M25

Socket-outlet
6134017

PLUG DSN³



Straight handle poly
512POD21

Inlet
6138017

MAIN FEATURES

Rated current (with wiring according to standard)	32 A	Ambient temperature	-40 °C to +60 °C
Maximum voltage	690 V	Flexible wiring (min-max)	2,5-6 mm ²
IP protection lid closed	IP66/IP67/IP69	Stranded wiring (min-max)	2,5-10 mm ²
IP protection plug connected	IP66/IP67/IP69	Other wiring	on request
Shock resistance	IK08	Keying positions	24

Load-break capability of the DECONTACTOR™

Comply with IEC/EN 60309-1 and IEC/EN 60309-4 standards	32 A/690 V
Load-break capability according to IEC/EN 60947-3/AC-22 A	32 A/690 V
Load-break capability according to IEC/EN 60947-3/AC-23 A	32 A/400 V
Short-circuit current I _{cc}	10 kA
Power kW AC-22/AC-23	15 kW

SOCKET-OUTLET female DSN³ (32 A)



INLET male DSN³ (32 A)



Dual-voltage socket-outlet (see p. 7)

20-24 V AC	2P	613408A	613808A
220-250 V AC	1P+N+E	6134015	6138015
380-440 V AC	3P+E	6134013	6138013
220-250 V AC / 380-440 V AC	3P+N+E	6134017	6138017
660-690 V AC	3P+E	6134193	6138193
380-400 V AC / 660-690 V AC	3P+N+E	6134197	6138197
Auxiliaries 30 A/500 V AC	+ 2 contacts	Ref. + 972	Ref. + 972

► Other voltages, frequencies and contact configurations are available (see page 10).



For a black colour GRP housing replace the second reference character 1 with 5.

INFO+

OPTIONS AND ACCESSORIES

Find the boxes, sleeves and handles at the end of the section page 34.



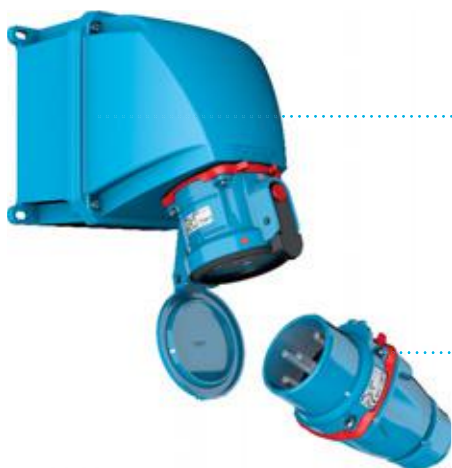

WALL MOUNTING SOCKET DSN6



Wall box poly 70°
513C7M25



Socket-outlet
6164017

PLUG DSN6



Straight handle poly
513POD30



Inlet
6168017

MAIN FEATURES

Rated current (with wiring according to standard)	63 A	Ambient temperature	-40 °C to +60 °C
Maximum voltage	1 000 V	Flexible wiring (min-max)	6-16 mm ²
IP protection lid closed	IP66/IP67/IP69	Stranded wiring (min-max)	10-25 mm ²
IP protection plug connected	IP66/IP67/IP69	Other wiring	on request
Shock resistance	IK08	Keying positions	24

Load-break capability of the DECONTACTOR™

Comply with IEC/EN 60309-1 and IEC/EN 60309-4 standards	(63 A/690 V) or (45 A/1 000 V)
Load-break capability according to IEC/EN 60947-3/AC-22 A	50 A/690 V
Load-break capability according to IEC/EN 60947-3/AC-23 A	63 A/400 V
Short-circuit current I _{cc}	10 kA
Power kW AC-22/AC-23	30 kW

SOCKET-OUTLET female DSN6 (63 A)



INLET male DSN6 (63 A)



Dual-voltage socket-outlet (see p. 7)

20-24 V AC	2P	616408A	616808A
190-230 V AC	3P+E	6164033	6168033
220-250 V AC	1P+N+E	6164015	6168015
380-440 V AC	3P+E	6164013	6168013
220-250 V AC 380-440 V AC	3P+N+E	6164017	6168017
660-690 V	3P+E	6164193	6168193
380-400 V 660-690 V	3P+N+E	6164197	6168197
Auxiliaries 16 A/400 V AC	+ 2 contacts	Ref. + 972	Ref. + 972
Auxiliaries 16 A/400 V AC	+ 4 contacts	Ref. + 264	Ref. + 264

► Other voltages, frequencies and contact configurations are available (see page 10).



For a black colour GRP housing replace the second reference character 1 with 5.

INFO+

OPTIONS AND ACCESSORIES





Find the boxes, sleeves and handles at the end of the section page 34.

















OPTIONS (DETAILS ON PAGE 216)

	DSN1 size 1	DSN3 size 2	DSN6 size 3
INDUSTRIAL-DOMESTIC ADAPTERS			
 <p>Industrial inlet MARECHAL® 1P+N+E domestic socket-outlet 10/16 A 230 V fuse protection 10 A and 16 A (with integrated fuse).</p>	6118015D11*	6138015D11*	NA
 <p>* Adapters are available in foreign standards : replace D11 by D40 for UK, D30 for Germany/NL/Lux, D06 for Italy.</p>			
LOCKING PIN FOR 2 PADLOCKS Ø 8 mm (PADLOCKS NOT SUPPLIED)			
	Socket-outlet ref. + 843	Socket-outlet ref. + 843	Socket-outlet ref. + 843
SAFETY HASP FOR UP TO 6 PADLOCKS			
	873A541	873A541	873A541
LARGER RELEASE BUTTON			
	Socket-outlet ref. + 453	Socket-outlet ref. + 453	Socket-outlet ref. + 453
INLET CAP IP66/IP67			
	611A426	613A426	616A426
IN-LINE CONNECTIONS (A PAIR OF FINGER DRAW PLATES TO AID CLOSING)			
	611A346	613A346	616A346
180° OPENING LID			
	Metal socket ref. + 10	Metal socket ref. + 10	Metal socket ref. + 10
SELF-RETURNING LID (WITHOUT FULL CLOSURE IP40)			
	Socket-outlet ref. + R	Socket-outlet ref. + R	Socket-outlet ref. + R
180° OPENING & SELF-RETURNING LID			
	Socket-outlet ref. + 18	Socket-outlet ref. + 18	Socket-outlet ref. + 18
SELF-CLOSING LID FOR INLET LOCKABLE (IP54)			
	NA	613A226	616A226
SELF-EJECTING (SEE REFERENCES AND OPTIONS DETAILS PAGE 228)			
			

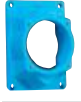

ACCESSORIES

(SEE PAGE 238 TO CROSS REFERENCE WITH OLDER PART NUMBERS)

SLEEVE		DSN1 size 1	DSN3 size 2	DSN6 size 3
POLY SLEEVE				
  DSN1	30°	511M3	512M3	513M3
	70°	511M7	512M7	513M7
	30°	551M3	552M3	553M3
	70°	551M7	552M7	553M7
METAL SLEEVE				
	0°	591M0	592M0	593M0
  DSN1	30°	591M3	592M3	593M3
	70°			593M7

TPM ELECTRICAL INLET WITH FLAP

DSN1
size 1

BLACK POLY HOUSING (IP55) WITH LID FOR MECHANICAL EJECTION SOCKET



Dimensions (LxHxD)











121 x 136 x 60

- 551B0065 Size 1 case without indicator light
- 551B0165 Size 1 case with 1+1 indicator lights
- 551B0265 Size 1 case with 1+2 indicator lights



ACCESSORIES

(SEE PAGE 238 TO CROSS REFERENCE WITH OLDER PART NUMBERS)

HANDLE		DSN1 size 1	DSN3 size 2	DSN6 size 3	
POLY HANDLE WITH GLAND					
 * Short	9-18 mm	511P0D18*			
	5-21 mm	511P0D21	512P0D21		
	10-30 mm			513P0D30	
 * Short	9-18 mm	551P0D18*			
	5-21 mm		552P0D21		
	10-30 mm			553P0D30	
 60° angle	9-18 mm	511P6D18			
 60° angle	9-18 mm	551P6D18			
POLY HANDLE WITH POLY CABLE GLAND (FOR A BLACK COLOUR HANDLE REPLACE THE SECOND REFERENCE CHARACTER 1 WITH 5)					
	5-12 mm	511P020P	512P020P	513P020P	Ref. +443 (DSN1 10-14 mm)
	9-18 mm	511P025P	512P025P	513P025P	Ref. +443 (DSN1 12-18 mm)
	14-25 mm	511P032P	512P032P	513P032P	Ref. +443
	18-32 mm		512P040P	513P040P	Ref. +443
METAL HANDLE WITH METAL GLAND (+ EARTHING WIRE)					
	7-13 mm		592P020M	593P020M	
	8-16 mm		592P025M	593P025M	
	16-24 mm		592P032M	593P032M	
	22-32 mm			593P040M	
POLY HANDLE WITHOUT CABLE GLAND (METRIC THREAD ENTRY, (FOR A BLACK COLOUR HANDLE REPLACE THE SECOND REFERENCE CHARACTER 1 WITH 5)					
	M20	511P0M20	512P0M20	513P0M20	Ref. +443
	M25	511P0M25	512P0M25	513P0M25	Ref. +443
	M32	511P0M32	512P0M32	513P0M32	Ref. +443
	M40		512P0M40	513P0M40	Ref. +443
METAL HANDLE WITHOUT CABLE GLAND (METRIC THREAD ENTRY)					
	M20		592P0M20	593P0M20	
	M25		592P0M25	593P0M25	
	M32		592P0M32	593P0M32	
	M40			593P0M40	

BOXES



DSN1
size 1

DSN3
size 2

DSN6
size 3

POLY BOX (FOR A BLACK COLOUR HANDLE REPLACE THE SECOND REFERENCE CHARACTER 1 WITH 5)



30°	M20	511B3M20	512B3M20	
30°	M25	511B3M25	512B3M25	513B3M25

METAL BOX (+ EARTHING WIRE)



20°	M20		592B2M20	593B2M20
20°	M25		592B2M25	593B2M25
20°	M32			593B2M32

POLY BOX + POLY SLEEVE (BLACK VERSION SEE ACCESSORIES DXN PAGE 169)



Extra earth bar ref:
51AA089

70°	Without Hole	511C7000	512C7000	513C7000
70°	Ø M20	511C7M20	512C7M20	
70°	Ø M25	511C7M25	512C7M25	513C7M25
70°	Ø M32	511C7M32	512C7M32	513C7M32
70°	Ø M40		512C7M40	513C7M40

METAL BOX (+ EARTHING WIRE) + POLY SLEEVE



30°	M20	511C3M20	512C3M20	513C3M20
30°	M25		512C3M25	513C3M25
30°	M32		512C3M32	513C3M32
30°	M40		512C3M40	513C3M40

METAL BOXES WITH METAL SLEEVE (+ EARTHING WIRE)



30°	M20		592C3M20	593C3M20
30°	M25		592C3M25	593C3M25
30°	M32		592C3M32	593C3M32
30°	M40			593C3M40



0°	M20		592C0M20	593C0M20
0°	M25		592C0M25	593C0M25
0°	M32		592C0M32	593C0M32
0°	M40			593C0M40







70°	M20			593C7M20
70°	M25			593C7M25
70°	M32			593C7M32
70°	M40			593C7M40



SPARE PARTS



PLUG		DSN1	DSN3	DSN6
1 Plug interior		611A010	311A010	313A010
2 Locking ring		611A583	311A583	616A583
3 Plug contact		611A011	311A011	616A011
4 Color-coded voltage gasket		611AB26	613AB26	313AB26
		611AR26	613AR26	313AR26
		611AV26	613AV26	313AV26
		611AN26	613AN26	313AN26
5 Plug casing		611A501	613A501	616A501



Remember to order the special removal key



Yellow disassembly key
31-A500-1

Contact us for spare parts.



SOCKET		DSN1	DSN3	DSN6
1	Socket Interior	611A020	311A020	313A020
2	Locking ring	611A583	311A583	616A583
3	Socket contact	611A021	311A021	616A021
4	Color-coded voltage gasket	611AB26	613AB26	313AB26
		611AR26	613AR26	313AR26
		611AV26	613AV26	313AV26
		611AN26	613AN26	313AN26
5	Socket Casing	611A524	613A524	616A524
6	Casing gasket	611A074	613A074	616A074

Contact us for spare parts.



DIMENSIONS

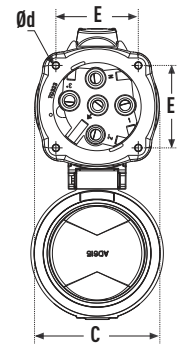
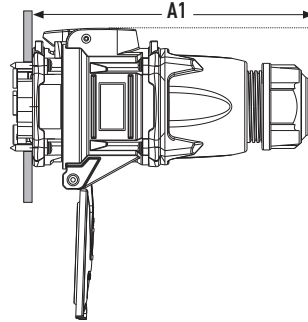
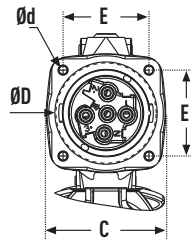
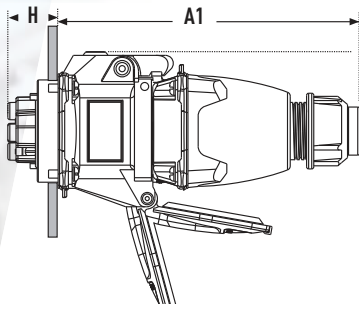

	A1	C	E	H	Ød*	ØD*
DSN1	147	58	42	25	4,5	51
DSN3	171	74	48	14	5	58
DSN6	184	84	55	16	5	68

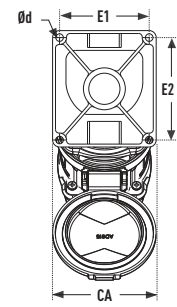
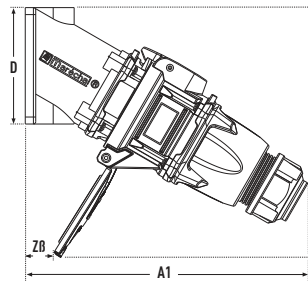
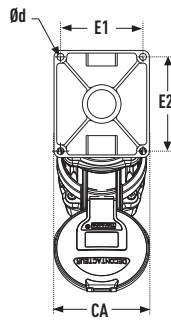
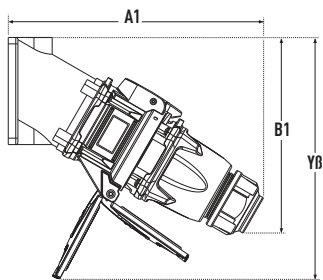

	A1	B1	CA	E1	E2	Ød*
DSN1	196	154	68	36/56	78	4,5
DSN3	213	159	84	70	70	6
DSN6	238	182	89	77	88	6,5

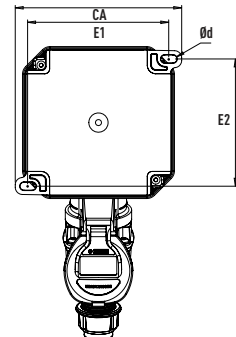
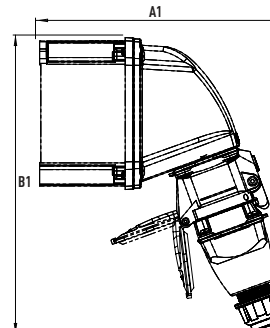
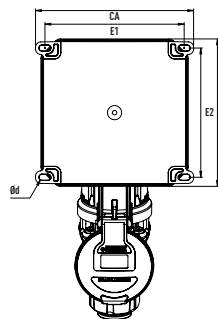
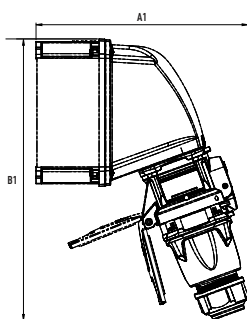

	A1	B1	CA	E1	E2	Ød*
DSN1	200	244	138	117	105,5	6,5
DSN3	207	262	138	117	105,5	6,5
DSN6	239	300	178	157	145,5	6,5

*Ød : maximum drilling diameter.

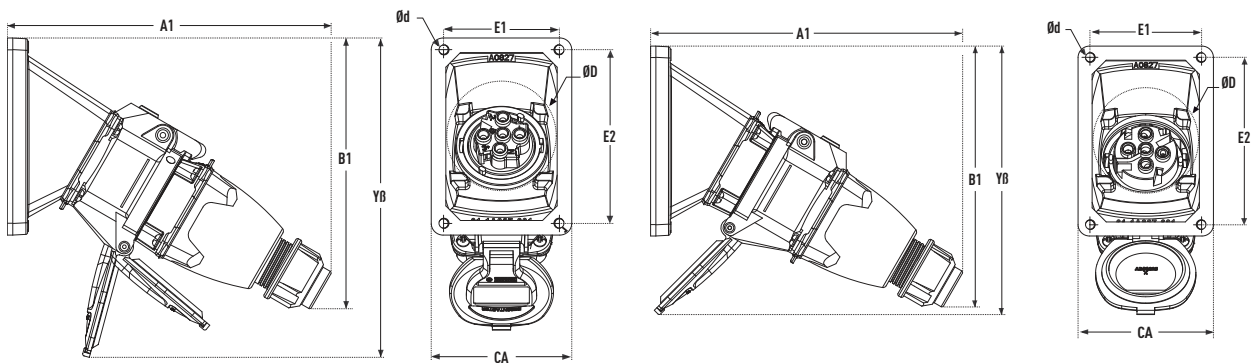

	A1	B1	CA	E1	E2	Ød*	ØD*
DSN1	177	148	77	63	95	5	51
DSN3	197	165	77	63	95	5,5	58
DSN6	212	178	77	63	95	5,5	68

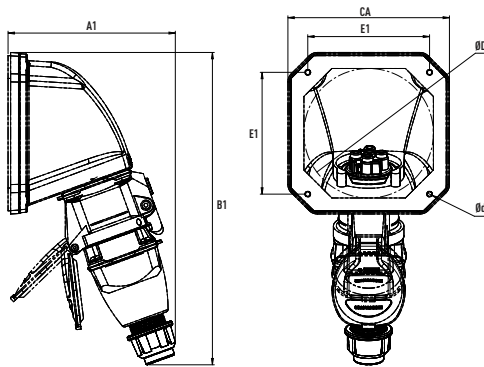

	A1	B1	CA	E1	Ød*	ØD*
DSN1	131	244	126	95	3.6	51
DSN3	138	262	126	95	3.6	58
DSN6	170	317	166	135	3,6	68

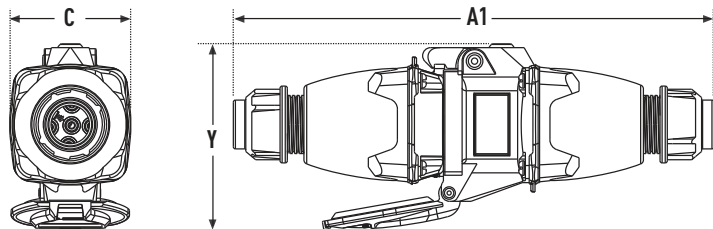

	A1	C	Y
DSN1	231	58	89
DSN3	265	74	116
DSN6	286	84	122

*Ød : maximum drilling diameter.