

# Telemecanique Sensors Detection components

## Panorama 2025



*Designed for small spaces in packaging machines*



# Telemecanique Sensors

## Simply easy!™

Founded over 100 years ago, Telemecanique Sensors is specialized in sensors and sensor-related technology. As a global leader in the sensors business, we help our customers select the right technology to get the best performance and reliability from their machines.



Focused on 3 core values – **Simplicity, Proximity and Expertise** – we have become experts in factory automation sensors as well as specialists in demanding applications, making our customers' lives "Simply easy!"

Telemecanique Sensors presents an expanded XU range of application photo-electric sensors to be embedded in automated lines for the packaging market segment.

With their diverse technical characteristics, high performance and smart management capabilities, they are designed to address a wide scope of specific needs.



### Sensor family per application

- > Marking detection
- > Very dark and light-absorbing object detection
- > Accurate detection
- > Colour object detection, from simple colour to very complex colour sorting
- > Transparent object detection, with or without reflector



Laser



Red light



White light



Blue light



RGB

Five light spots

### Choose the casing, connection type and size

- > Plastic or metal casing
- > Pre-cabled, with pigtail or connector
- > Miniature, sub-miniature and compact size

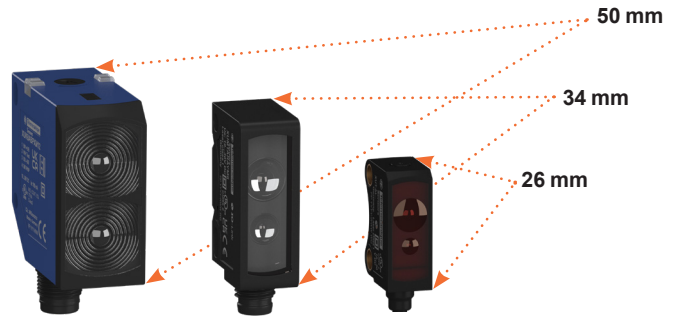

Enable smart sensors  
functions through IO-Link



### Smart devices communicate via IO-Link protocol

- > Install your new IO-Link sensor easily: automatic reading of the device identification file (IODD) and automatic detection of the sensor output mode
- > Automated parameter settings: configure the detection parameters
- > Extended diagnostics, with real-time information for optimised usage and maintenance



## SPOTLIGHT: Photoelectric sensors XUM XUB XUN

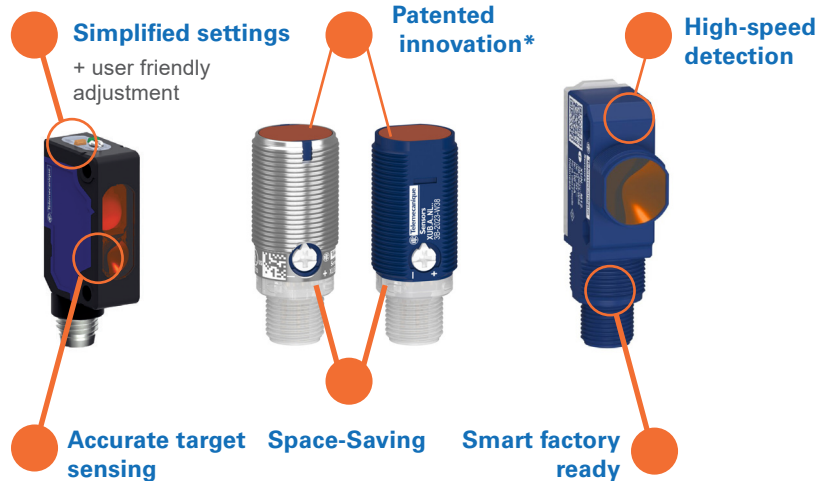

\*Small reflector placed on "thru beam" sensors, reaching up to 30m, enabling the user to align the sensors in less than 4 minutes (compared to 15 minutes previously). This reduces installation time by a factor of 3!

# Pressure switches: XM Range

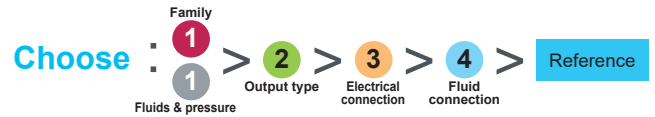

XMLP Electronic transmitter		Hydraulic oils, air, fresh water					
M12 4 pin (male)		Analog output					
--30...+85° C				4...20 mA	0...10 V	0.5...4.5 V	
Bar	psi						
-1	-14.5			XMLPM00GD21F	XMLPM00GD71F	XMLPM00GD11F	
1	14.5			XMLP001GD21F	XMLP001GD71F	XMLP001GD11F	
6	87			XMLP006GD21F	XMLP006GD71F	XMLP006GD11F	
10	145			XMLP010BD21F	XMLP010BD71F	XMLP010BD11F	
16	232			XMLP016BD21F	XMLP016BD71F	XMLP016BD11F	
25	362			XMLP025BD21F	XMLP025BD71F	XMLP025BD11F	
40	580			XMLP040BD21F	XMLP040BD71F	XMLP040BD11F	
60	870			XMLP060BD21F	XMLP060BD71F	XMLP060BD11F	
100	1450			XMLP100BD21F	XMLP100BD71F	XMLP100BD11F	
160	2320			XMLP160BD21F	XMLP160BD71F	XMLP160BD11F	
250	3625			XMLP250BD21F	XMLP250BD71F	XMLP250BD11F	
400	5800			XMLP400BD21F	XMLP400BD71F	XMLP400BD11F	
600	8700			XMLP600BD21F	XMLP600BD71F	XMLP600BD11F	

ZMLP Display and switch		4-20 mA analog + switching output		2 switching outputs	
M12 4 pin (male)		NO/NC Programmable		NO/NC Programmable	
PNP		Window	Hysteresis	Fixed hysteresis	
		ZMLPA1P2SW	ZMLPA1P2SH	ZMLPA2P0SH	
M12 4 pin (female)		Quick mounting bracket		Horizontal plan	Vertical plan or pipe
				XMLPZLH01	XMLPZLV01

Only usable with 4-20mA analog output XMLP electronic transmitter

### Cabling XM

Connectors (female)		PUR pre wired connectors (female) (3)			PUR Jumper cables			
M12	straight	straight	elbowed	elbowed PNP LED	M12 (female)	straight	elbowed	
(1)	4 pin	XZCC12FDM40B	XZCC12FCM40B		M12 (male)	straight	straight	
(2)	4 pin	XZCC12FDP40B	XZCC12FCP40B		4 pin	1 m	XZCR1511041C1	XZCR1512041C1
(1)	5 pin	XZCC12FDM50B	XZCC12FCM50B		2 m	XZCR1511041C2	XZCR1512041C2	

(1) Steel ring (2) Plastic ring (3) For a PVC cable, add the letter V after the P. Example: XZCPpppppp become XZCPVpppppp

# Pressure switches: XM Range

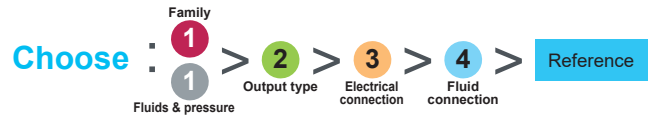

XMLA / XMLB Electromechanical		Hydraulic oils, air, fresh water, sea water / Temp. : up to 70° C									
Screw terminal		1 C/O single pole contact fixed differential			1 C/O single pole contact adjustable differential						
		Bar	psi	ISO M20	Pg13	DIN connector	ISO M20	Pg13	DIN connector		
		-1	-14.5	XMLAM01V2S12	XMLAM01V2S11	XMLAM01V2C11	XMLBM02V2S12	XMLBM02V2S11	XMLBM02V2C11		
		2.5	36.3	XMLA002A2S12	XMLA002A2S11	XMLA002A2C11	XMLB002A2S12	XMLB002A2S11	XMLB002A2C11		
		4	58	XMLA004A2S12	XMLA004A2S11	XMLA004A2C11	XMLB004A2S12	XMLB004A2S11	XMLB004A2C11		
		10	145	XMLA010A2S12	XMLA010A2S11	XMLA010A2C11	XMLB010A2S12	XMLB010A2S11	XMLB010A2C11		
		20	290	XMLA020A2S12	XMLA020A2S11	XMLA020A2C11	XMLB020A2S12	XMLB020A2S11	XMLB020A2C11		
		35	508	XMLA035A2S12	XMLA035A2S11	XMLA035A2C11	XMLB035A2S12	XMLB035A2S11	XMLB035A2C11		
		Hydraulic oils / Temp. : up to 160° C									
		Bar	psi	ISO M20	Pg13	DIN connector	ISO M20	Pg13	DIN connector		
G 1/4 (female)		1	14.5	XMLA001R2S12	XMLA001R2S11	XMLA001R2C11	XMLB001R2S12	XMLB001R2S11	XMLB001R2C11		
		70	1015	XMLA070D2S12	XMLA070D2S11	XMLA070D2C11	XMLB070D2S12	XMLB070D2S11	XMLB070D2C11		
		160	2320	XMLA160D2S12	XMLA160D2S11	XMLA160D2C11	XMLB160D2S12	XMLB160D2S11	XMLB160D2C11		
		300	4350	XMLA300D2S12	XMLA300D2S11	XMLA300D2C11	XMLB300D2S12	XMLB300D2S11	XMLB300D2C11		
		500	7250	XMLA500D2S12	XMLA500D2S11	XMLA500D2C11	XMLB500D2S12	XMLB500D2S11	XMLB500D2C11		

XMLR Electronic + Display		Hydraulic oils, air, fresh water, refrigerant fluids					
M12 4 pin or 5 pin		-20... +80° C		Analog output		Analog + 2 switching outputs	
		Bar	psi	4...20 mA	0...10 V	PNP - NO/NC programmable	
		Bar	psi	4...20 mA	0...10 V	4...20 mA	
		-1	-14.5	XMLRM01G0T25	XMLRM01G0T75	XMLRM01G2P25	
		1	14.5	XMLR001G0T25	XMLR001G0T75		
		2.5	35.2	XMLR2D5G0T25	XMLR2D5G0T75		
		10	145	XMLR010G0T25	XMLR010G0T75	XMLR010G2P25	
		16	232	XMLR016G0T25	XMLR016G0T75	XMLR016G2P25	
		25	362	XMLR025G0T25	XMLR025G0T75		
		40	580	XMLR040G0T25	XMLR040G0T75	XMLR040G2P25	
		100	1450	XMLR100M0T25	XMLR100M0T75		
		160	2320	XMLR160M0T25	XMLR160M0T75		
		250	3625	XMLR250M0T25	XMLR250M0T75	XMLR250M2P25	
	400	5800	XMLR400M0T25	XMLR400M0T75	XMLR400M2P25		
	600	8700	XMLR600M0T25	XMLR600M0T75			

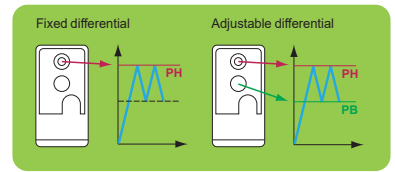

		Hydraulic oils, air, fresh water, refrigerant fluids					
G 1/4A (female)		-20... +80° C		Analog + switching output		2 switching outputs	
		Bar	psi	4...20 mA	0...10 V	PNP - NO/NC programmable	
		Bar	psi	4...20 mA	0...10 V	PNP - NO/NC programmable	
		-1	-14.5	XMLRM01G1P25	XMLRM01G1P75	XMLRM01G2P05	
		1	14.5	XMLR001G1P25	XMLR001G1P75	XMLR001G2P05	
		2.5	35.2	XMLR2D5G1P25	XMLR2D5G1P75	XMLR2D5G2P05	
		10	145	XMLR010G1P25	XMLR010G1P75	XMLR010G2P05	
		16	232	XMLR016G1P25	XMLR016G1P75	XMLR016G2P05	
		25	362	XMLR025G1P25	XMLR025G1P75	XMLR025G2P05	
		40	580	XMLR040G1P25	XMLR040G1P75	XMLR040G2P05	
		100	1450	XMLR100M1P25	XMLR100M1P75	XMLR100M2P05	
		160	2320	XMLR160M1P25	XMLR160M1P75	XMLR160M2P05	
		250	3625	XMLR250M1P25	XMLR250M1P75	XMLR250M2P05	
		400	5800	XMLR400M1P25	XMLR400M1P75	XMLR400M2P05	
		600	8700	XMLR600M1P25	XMLR600MP75	XMLR600M2P05	

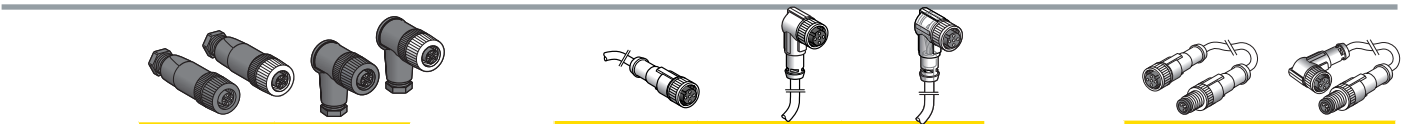

Cabling XM			Connectors (female)			PUR pre wired connectors (female) (3)			PUR Jumper cables			
M12	straight	elbowed	M12	straight	elbowed	elbowed PNP LED	M12 (female)	straight	elbowed	M12 (male)	straight	elbowed
(1)	4 pin	XZCC12FDM40B	XZCC12FCM40B	4 pin	2 m	XZCP1141L2	XZCP1241L2	XZCP1340L2	4 pin	1 m	XZCR1511041C1	XZCR1512041C1
(2)	4 pin	XZCC12FDP40B	XZCC12FCP40B		5 m	XZCP1141L5	XZCP1241L5	XZCP1340L5		2 m	XZCR1511041C2	XZCR1512041C2
(1)	5 pin	XZCC12FDM50B	XZCC12FCM50B		10 m	XZCP1141L10	XZCP1241L10	XZCP1340L10				

(1) Steel ring (2) Plastic ring

(3) For a PVC cable, add the letter V after the P. Example: XZCPpppppp become XZCPVpppppp

# Limit switches: XC Range

Choose: **1** > **2** > **3** > **4** > Reference

Body      Head      Contact      Connection

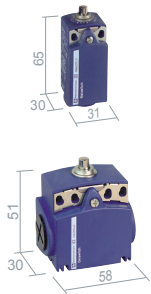

Series	Material	Contact	Body	Head	Connection	1	2	3	4	Reference
XCKD	Metal	NO+NC Snap	M16	XCKD2110P16	XCKD2102P16	XCKD2121P16	XCKD2106P16	XCKD2118P16	XCKD2145P16	
			Pg11	XCKD2110G11	XCKD2102G11	XCKD2121G11	XCKD2106G11	XCKD2118G11	XCKD2145G11	
			M12 5P	XCKD2110M12	XCKD2102M12	XCKD2121M12	XCKD2106M12	XCKD2118M12	XCKD2145M12	
XCKP	Plastic	NO+NC Snap	M16	XCKP2110P16	XCKP2102P16	XCKP2121P16	XCKP2106P16	XCKP2118P16	XCKP2145P16	
			Pg11	XCKP2110G11	XCKP2102G11	XCKP2121G11	XCKP2106G11	XCKP2118G11	XCKP2145G11	
			M12 4P	XCKP2110M12	XCKP2102M12	XCKP2121M12	XCKP2106M12	XCKP2118M12	XCKP2145M12	
XCKT	Plastic	NO+NC Snap	M16	XCKT2110P16	XCKT2102P16	XCKT2121P16	XCKT2106P16	XCKT2118P16	XCKT2145P16	
			Pg11	XCKT2110G11	XCKT2102G11	XCKT2121G11	XCKT2106G11	XCKT2118G11	XCKT2145G11	



Series	Material	Contact	Body	Head	Connection	1	2	3	4	Reference
XCMD	Metal	NO+NC Snap	1 m	XCMD2110L1	XCMD2102L1	XCMD2124L1	XCMD21F0L1	XCMD21F2L1	XCMD2115L1	XCMD2116L1
		NO+NC Slow	1 m	XCMD2510L1	XCMD2502L1	XCMD2524L1	XCMD25F0L1	XCMD25F2L1	XCMD2515L1	XCMD2516L1
		NO+NC Snap	M12 5P	XCMD2110C12	XCMD2102C12	XCMD2124C12	XCMD21F0C12	XCMD21F2C12	XCMD2115C12	XCMD2116C12
		1 C/O Snap	M12 4P	XCMD2110M12	XCMD2102M12	XCMD2124M12	XCMD21F0M12	XCMD21F2M12	XCMD2115M12	XCMD2116M12



Series	Material	Contact	Body	Head	Connection	1	2	3	4	Reference		
XC SM	Metal	Safety contacts (3)	Cable 1m	Type of operator	Metal end plunger	XCSM3710L1	XCSM3702L1	2NC+2NO Snap	Type of operator	Metal end plunger	XCSM4110L1	XCSM4102L1
				Steel roller plunger	XCSM4110L1	XCSM4102L1						
		2NC+NO Slow	Cable 2m	Metal end plunger	XCSM3710L2	XCSM3702L2	Metal end plunger	XCSM4110L2	XCSM4102L2			
				Steel roller plunger	XCSM3710L5	XCSM3702L5	Steel roller plunger	XCSM4110L5	XCSM4102L5			



Series	Material	Contact	Body	Head	Connection	1	2	3	4	Reference
XCKM	Metal	NO+NC Snap	M20	XCKM110H29	XCKM102H29	XCKM121H29	XCKM115H29	XCKM106H29		
			Pg11	XCKM110	XCKM102	XCKM121	XCKM115	XCKM106		
XCKL	Metal	NO+NC Snap	CG	XCKL110	XCKL102	XCKL121	XCKL115	XCKL106		



Series	Material	Contact	Body	Head	Connection	1	2	3	4	Reference	
XCKJ	Metal	NO+NC Snap	M20	XCKJ161H29	XCKJ167H29	XCKJ10511H29	XCKJ10513H29	XCKJ10541H29	XCKJ10559H29		
				Pg13	XCKJ161	XCKJ167	XCKJ10511	XCKJ10513	XCKJ10541	XCKJ10559	
				1/2NPT	XCKJ161H7	XCKJ167H7	XCKJ10511H7	XCKJ10513H7	XCKJ10541H7	XCKJ10559H7	
				M12 5P	XCKJ161D	XCKJ167D	XCKJ10511D	XCKJ10513D	XCKJ10541D	XCKJ10559D	

(1) Plastic roller      (2) Steel roller



Series	Material	Contact	Body	Head	Connection	1	2	3	4	Reference
XC SA	Metal	M20	NC+2NO Slow	XCSA502	XCSA702	XCSA802	Accessories		XCSZ01	XCSZ03
			Pg13	XCSA501	XCSA701	XCSA801				
			1/2NPT	XCSA503	XCSA703	XCSA803				



Series	Material	Contact	Body	Head	Connection	1	2	3	4	Reference
XC SPA	Plastic	M16	NC+N0 Slow	XCSPA592	XCSPA792	XCSPA892	XCSPA992	XCSPA492	Accessories	
			Pg11	XCSPA591	XCSPA791	XCSPA891	XCSPA991	XCSPA491	XCSZ11	XCSZ13
			1/2NPT	XCSPA593	XCSPA793	XCSPA893	XCSPA993	XCSPA493		

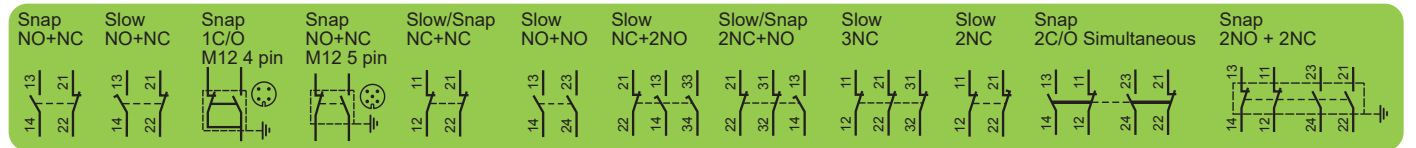

- M16 Tapped M16x1.5 for ISO cable gland
- M20 Tapped M20x1.5 for ISO cable gland
- Pg11 Tapped for a N°11 cable gland
- Pg13 Tapped for a N°13 cable gland
- 1/2NPT Tapped for a 1/2" NPT
- PF1/2 Tapped for a PF1/2"
- M12 5P Connector M12, 5 pin
- M12 4P Connector M12, 4 pin
- CG Tapped with cable gland included

Cabling XC		PUR pre wired connectors			Connectors (female)			
		straight	elbowed	elbowed PNP LED	M12	straight	elbowed	
M12	4 pin	2 m	XZCP1141L2	XZCP1241L2	XZCP1340L2	(2) 4 pin	XZCC12FDM40B	XZCC12FCM40B
	5 m		XZCP1141L5	XZCP1241L5	XZCP1340L5	(3) 4 pin	XZCC12FDP40B	XZCC12FCP40B
	10 m		XZCP1141L10	XZCP1241L10	XZCP1340L10	(2) 5 pin	XZCC12FDM50B	XZCC12FCM50B
	5 pin	5 m	XZCP1164L5	XZCP1264L5				

(1) For a PVC cable, add the letter V after the P. Example: XZCPpppppp become XZCPVpppppp

(2) Steel ring      (3) Plastic ring

# Limit switches: XC Range

## XCKP / XCKD / XCKT

Plastic / Metal / Plastic

	NO+NC Snap	NO+2NC Snap	NO+NC Slow	NC+NC Slow	NC+NC Snap	NO+NO Slow
<b>XCKP</b>	ZCP21	ZCP39	ZCP25	ZCP27	ZCP29	ZCP28
<b>XCKD</b>	ZCD21	ZCD39	ZCD25	ZCD27	ZCD29	ZCD28

Cable entry	M16	M20	Pg11	Pg13.5	1/2 NPT	PF1/2
<b>XCKP</b>	ZCPEP16	ZCPEP20	ZCPEG11	ZCPEG13	ZCPEN12	ZCPEF12
<b>XCKD</b>	ZCDEP16	ZCDEP20	ZCDEG11	ZCDEG13	ZCDEN12	ZCDEF12

	NO+NC Snap	NC+NC Snap
<b>XCKT</b>	M12 4P ZCP21M12	M16 ZCT21P16
	M12 5P ZCD21M12	Pg11 ZCT21G11
		NO+NC Slow
		M16 ZCT25P16
		Pg11 ZCT25G11

## XCMD

Metal

	NO+NC Snap	NO+NC Slow	2NO+2NC Snap	NO+NC Snap	1C/O Snap
ZCMD21					
ZCMD25					
ZCMD4D					
ZCMD21C12				M12 5P	
ZCMD21M12					M12 4P

1 m	ZCMC21L1	ZCMD21L1	ZCMC25L1	ZCMD25L1	ZCMC4D1	ZCMD41L1
2 m	ZCMC21L2	ZCMD21L2	ZCMC25L2	ZCMD25L2	ZCMC4D2	ZCMD41L2
5 m	ZCMC21L5	ZCMD21L5	ZCMC25L5	ZCMD25L5	ZCMC4D5	ZCMD41L5

## XCKM / XCKL

Metal

XCKM/XCKL	NO+NC Snap	NO+NC Slow
3xPg11	ZCKM1	ZCKM5
3xM20	ZCKM1H29	ZCKM5H29
PE		ZCKL1
1/2 NPT		ZCKL1H7
		ZCKL5
		ZCKL5H7

XCKS	NO+NC Snap	NO+NC Slow
Pg13	ZCKS1	ZCKS5
M20	ZCKS1H29	ZCKS5H29

XCKJ	NO+NC Snap	NO+NC Slow	2C/O Simult. Snap
Pg13	ZCKJ1	ZCKJ5	ZCKJ2
M20	ZCKJ1H29	ZCKJ5H29	ZCKJ2H29
1/2 NPT	ZCKJ1H7	ZCKJ5H7	ZCKJ2H7
M12 5P	ZCKJ1D	ZCKJ5D	-

## XCKJ

Metal

ZCKE05	ZCKY41	ZCKY43	ZCKY59	ZCKY51	ZCKY53

## XCKS

Plastic

ZCKD01	ZCKD02	ZCKD05	ZCKY31	ZCKY39	ZCKY41

# Inductives: XS Range

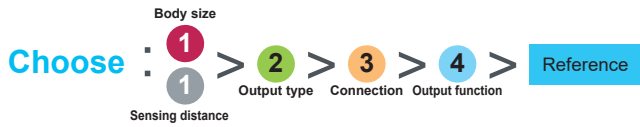

			M8	
			1.5 mm	2.5 mm
DC3	PNP	cable	XS508B1PAL2	XS108B3PAL2
		connector	XS508B1PAM8	XS108B3PAM8
	NPN	cable	XS508B1NAL2	XS108B3NAL2
		connector	XS508B1NAM8	XS108B3NAM8
DC2		cable	XS508BSCAL2	XS608B3CAL2
		connector	XS508BSCAL01M12	XS608B3CAL01M12
DC3	PNP	cable	XS508BLPAL2	XS608B1PAL2
		connector	XS508BLPAM12	XS608B1PAM12
	NPN	cable	XS508BLNAL2	XS608B1NAL2
		connector	XS508BLNAM12	XS608B1NAM12
DC2		cable	XS508B1DAL2	XS608B1DAL2
		connector	XS508B1DAM12	XS608B1DAM12
AC/DC		cable		
		connector		
Output function		NO	A	A
		NC	B	B
		NO + NC		

		M12		
		2 mm	4 mm	
DC3	PNP	cable	XS512B1PAL2	XS112B3PAL2
		connector	XS512B1PAM12	XS112B3PAM12
	NPN	cable	XS512B1NAL2	XS112B3NAL2
		connector	XS512B1NAM12	XS112B3NAM12
DC2		cable	XS512BSDAL2	XS612B3DAL2
		connector	XS512BSDAM12	XS612B3DAM12
DC3	PNP	cable	XS512BLPAL2	XS612B1PAL2
		connector	XS512BLPAM12	XS612B1PAM12
	NPN	cable	XS512BLNAL2	XS612B1NAL2
		connector	XS512BLNAM12	XS612B1NAM12
DC2		cable	XS512B1DAL2	XS612B1DAL2
		connector	XS512B1DAM12	XS612B1DAM12
AC/DC		cable	XS512B1MAL2	XS612B1MAL2
		connector	XS512B1MAU20	XS612B1MAU20
Output function		A		A
		B		B
			(short only) C	

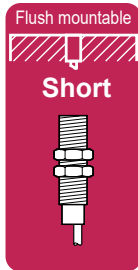

			M18	
			5 mm	8 mm
DC3	PNP	cable	XS518B1PAL2	XS118B3PAL2
		connector	XS518B1PAM12	XS118B3PAM12
	NPN	cable	XS518B1NAL2	XS118B3NAL2
		connector	XS518B1NAM12	XS118B3NAM12
DC2		cable	XS518BSDAL2	XS618B3DAL2
		connector	XS518BSDAM12	XS618B3DAM12
DC3	PNP	cable	XS518BLPAL2	XS618B1PAL2
		connector	XS518BLPAM12	XS618B1PAM12
	NPN	cable	XS518BLNAL2	XS618B1NAL2
		connector	XS518BLNAM12	XS618B1NAM12
DC2		cable	XS518B1DAL2	XS618B1DAL2
		connector	XS518B1DAM12	XS618B1DAM12
AC/DC		cable	XS518B1MAL2	XS618B1MAL2
		connector	XS518B1MAU20	XS618B1MAU20
Output function		NO	A	A
		NC	B	B
		NO + NC		(short only) C

		M30		
		10 mm	15 mm	
DC3	PNP	cable	XS530B1PAL2	XS130B3PAL2
		connector	XS530B1PAM12	XS130B3PAM12
	NPN	cable	XS530B1NAL2	XS130B3NAL2
		connector	XS530B1NAM12	XS130B3NAM12
DC2		cable	XS530BSDAL2	XS630B3DAL2
		connector	XS530BSDAM12	XS630B3DAM12
DC3	PNP	cable	XS530BLPAL2	XS630B1PAL2
		connector	XS530BLPAM12	XS630B1PAM12
	NPN	cable	XS530BLNAL2	XS630B1NAL2
		connector	XS530BLNAM12	XS630B1NAM12
DC2		cable	XS530B1DAL2	XS630B1DAL2
		connector	XS530B1DAM12	XS630B1DAM12
AC/DC		cable	XS530B1MAL2	XS630B1MAL2
		connector	XS530B1MAU20	XS630B1MAU20
Output function		A		A
		B		B
			(short only) C	

## XS Miniature



			D4	
			0.8 mm	1.5 mm
DC3	PNP	cable	XS504R1PAL2	XS604R1PAL2
		connector	XS504R1PAM08	XS604R1PAM08
	NPN	cable	XS504R1NAL2	XS604R1NAL2
		connector	XS504R1NAM08	XS604R1NAM08
Output function		NO	A	A
		NC	B	B

		M5		
		0.8 mm	1.5 mm	
DC3	PNP	cable	XS505R1PAL2	XS605R1PAL2
		connector	XS505R1PAM08	XS605R1PAM08
	NPN	cable	XS505R1NAL2	XS605R1NAL2
		connector	XS505R1NAM08	XS605R1NAM08
Output function		A		A
		B		B

# Inductives: XS Range

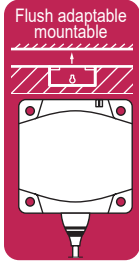
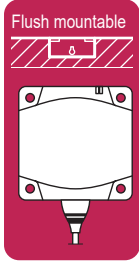

			U 8x22x8 mm	U 15x32x8 mm	U 26x26x13 mm	U 40x40x15 mm
Sensing distance			2.5 mm	5 mm	10 mm	15 mm
DC3	PNP	cable	XS7J1A1PAL2	XS7F1A1PAL2	XS7E1A1PAL2	XS7C1A1PAL2
		connector	XS7J1A1PAL01M8	XS7F1A1PAL01M8	XS7E1A1PAM8	XS7C1A1PAM8
	NPN	cable	XS7J1A1NAL2	XS7F1A1NAL2	XS7E1A1NAL2	XS7C1A1NAL2
		connector				XS7C1A1NAM8
DC2	cable	XS7J1A1DAL2	XS7F1A1DAL2	XS7E1A1DAL2	XS7C1A1DAL2	
	connector		XS7F1A1DAL01M8	XS7E1A1DAM8	XS7C1A1DAM8	

			U 26x26x13 mm	U 40x40x15 mm
Sensing distance			15 mm	25 mm
DC3	PNP	cable	XS8E1A1PAL2	XS8C1A1PAL2
		connector	XS8E1A1PAM8	XS8C1A1PAM8
	NPN	cable	XS8E1A1NAL2	XS8C1A1NAL2
		connector	XS8E1A1NAM8	XS8C1A1NAM8
AC/DC	cable	XS8E1A1MAL2	XS8C1A1MAL2	
	connector	XS8E1A1MAL01U20	XS8C1A1MAL01U20	

Output function	NO	A	B	A	B
NC					



Screw terminal M 20



Connector M 12, 4 pin

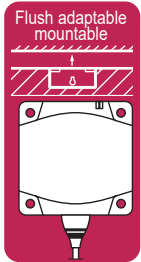
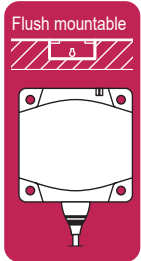

			U 80x80x26 mm	Cubic	U 40x40x117 mm	20 mm	40 mm
Sensing distance			40 mm				
DC3	PNP	cable	XS7D1A1PAL2		NO+NC	XS8C2A1PCM12	XS8C2A4PCM12
		connector	XS7D1A1PAM12		NO+NC	XS8C2A1NCM12	XS8C2A4NCM12
	NPN	cable	XS7D1A1NAL2		NO	XS8C2A1DAM12	XS8C2A4DAM12
		connector	XS7D1A1NAM12		NO	XS8C2A1MAU20	XS8C2A4MAU20
DC2	cable	XS7D1A1DAL2		DC4 PNP	NO+NC	XS8C4A1PCP20	XS8C4A4PCP20
	connector	XS7D1A1DAM12		NPN	NO+NC	XS8C4A1NCP20	XS8C4A4NCP20
AC/DC	cable	XS7D1A1MAL2	NO or NC	XS8C4A1DP P20	XS8C4A4DP P20		
	connector	XS7D1A1MAU20	NO or NC	XS8C4A1MP P20	XS8C4A4MP P20		

Select the type of connection	M20	P20	P20
	PG13	G13	G13
	1/2" NPT	N12	N12

DC3 24 V	DC4 24 V

Accessories	For 26x26	For 40x40
	XSZBE00	XSZBC00
	XSZBE90	XSZBC90

Accessories	M8	M12	M18	M30
	XSZB108	XSZB112	XSZB118	XSZB130

AC/DC 24...240 V	DC2 24 V

# Rotation monitoring: XSAV Range

Choose: **1** Speed > **2** Output Type > Reference

				Low Speed	High Speed
M30	Flush	cable	Sensing distance	10 mm	10 mm
			Output type	DC3-PNP	XSAV11373
			AC/DC	XSAV11801	XSAV12801

## Accessories



M8	XSZB108
M12	XSZB112
M18	XSZB118
M30	XSZB130

## Cabling XS

PUR pre wired connectors (female) (1)				
M12		straight	elbowed	elbowed PNP LED
4 pin	2 m	XZCP1141L2	XZCP1241L2	XZCP1340L2
	5 m	XZCP1141L5	XZCP1241L5	XZCP1340L5
	10 m	XZCP1141L10	XZCP1241L10	XZCP1340L10

Connectors (female)			
M12		straight	elbowed
4 pin	(2)	XZCC12FDM40B	XZCC12FCM40B
	(3)	XZCC12FDP40B	XZCC12FCP40B





(1) For a PVC cable, add the letter V after the P. Example: XZCPpppppp become XZCPVpppppp

(2) Steel ring (3) Plastic ring

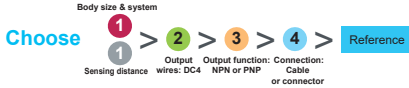
# Photo-electrics: XU Range

*XU miniature, cylindrical and hybrid model*

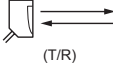

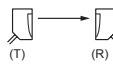
				M18 (1) metal	M18 (1) plastic	M18 (2) metal	M18 (2) plastic	Hybrid	Miniature			
				NO + NC	NO + NC	NO + NC	NO + NC	NO + NC	NO or NC			
<b>Diffuse</b>  (T/R)	1 m	PNP	cable	XUB5BPXNL2	XUB5APXNL2			XUN5APXNL2	1.9 m	XUM5APXBL2		
			connector 4P*	XUB5BPXNM12	XUB5APXNM12			XUN5APXNM12		XUM5APXBM8		
			IO-Link	XUB5BPYNM12	XUB5APYNM12			XUN5APYNM12				
		NPN	cable	XUB5BNXNL2	XUB5ANXNL2			XUN5ANXNL2	XUM5ANXBL2			
			connector 4P	XUB5BNXNM12	XUB5ANXNM12			XUN5ANXNM12	XUM5ANXBM8			
	0.6 m	PNP	cable	XUB6BPXNL2	XUB6APXNL2	0.5 m	XUB6BNXWL2	XUB6APXWL2	XUN6APXNL2	0.25 m	XUM6APXBL2	
			connector 4P	XUB6BPXNM12	XUB6APXNM12		XUB6BNXWM12	XUB6APXWM12	XUN6APXNM12		XUM6APXBM8	
			IO-Link	XUB6BPYNM12	XUB6APYNM12	XUB6BPYWM12	XUB6APYWM12	XUN6APYNM12				
		NPN	cable	XUB6BNXNL2	XUB6ANXNL2	XUB6BPXWL2	XUB6ANXWL2	XUN6ANXNL2	XUM6ANXBL2			
			connector 4P	XUB6BNXNM12	XUB6ANXNM12	XUB6BPXWM12	XUB6ANXWM12	XUN6ANXNM12	XUM6ANXBM8			
<b>Background Suppression</b>  Background suppression (BGS)	0.3 m	PNP	cable	XUB8BPXNL2	XUB8APXNL2	0.15 m	XUB8BPXWL2	XUB8APXWL2	XUN8APXNL2	0.3 m	XUM8APXBL2	
			connector 4P	XUB8BPXNM12	XUB8APXNM12		XUB8BPXWM12	XUB8APXWM12	XUN8APXNM12		XUM8APXBM8	
			IO-Link	XUB8BPYNM12	XUB8APYNM12	XUB8BPYWM12	XUB8APYWM12	XUN8APYNM12				
		NPN	cable	XUB8BNXNL2	XUB8ANXNL2	XUB8BNXWL2	XUB8ANXWL2	XUN8ANXNL2	XUM8ANXBL2			
			connector 4P	XUB8BNXNM12	XUB8ANXNM12	XUB8BNXWM12	XUB8ANXWM12	XUN8ANXNM12	XUM8ANXBM8			
	<b>Polarized Reflex</b>  (T/R)	7 m	PNP	cable	XUB9BPXNL2	XUB9APXNL2	5.5 m	XUB9BNXWL2	XUB9APXWL2	XUN9APXNL2	8 m	XUM9APXBL2
				connector 4P	XUB9BPXNM12	XUB9APXNM12		XUB9BNXWM12	XUB9APXWM12	XUN9APXNM12		XUM9APXBM8
				IO-Link	XUB9BPYNM12	XUB9APYNM12	XUB9BPYWM12	XUB9APYWM12	XUN9APYNM12			
			NPN	cable	XUB9BNXNL2	XUB9ANXNL2	XUB9BPXWL2	XUB9ANXWL2	XUN9ANXNL2	XUM9ANXBL2		
				connector 4P	XUB9BNXNM12	XUB9ANXNM12	XUB9BPXWM12	XUB9ANXWM12	XUN9ANXNM12	XUM9ANXBM8		
Accessory: Reflector				XUZC50	XUZC50	XUZC50	XUZC50	XUZC50	XUZC50	XUZC50		
<b>Thru-beam receiver</b>  (R)		30 m	PNP	cable	XUB2BPXNL2R	XUB2APXNL2R	17 m	XUB2BNXWL2R	XUB2APXWL2R	XUN2APXNL2R	30 m	XUM2APXBL2R
				connector 4P	XUB2BPXNM12R	XUB2APXNM12R		XUB2BNXWM12R	XUB2APXWM12R	XUN2APXNM12R		XUM2APXBM8R
				IO-Link	XUB2BPYNM12R	XUB2APYNM12R	XUB2BPYWM12R	XUB2APYWM12R	XUN2APYNM12R			
			NPN	cable	XUB2BNXNL2R	XUB2ANXNL2R	XUB2BPXWL2R	XUB2ANXWL2R	XUN2ANXNL2R	XUM2ANXBL2R		
				connector 4P	XUB2BNXNM12R	XUB2ANXNM12R	XUB2BPXWM12R	XUB2ANXWM12R	XUN2ANXNM12R	XUM2ANXBM8R		
	<b>Transmitter</b>				cable	XUB2BKXNL2T	XUB2BKXNL2T	XUB2BKXWL2T	XUB2AKXWL2T	XUN2AKXNL2T	XUM2AKXBL2T	
					connector 4P	XUB2BKXNM12T	XUB2BKXNM12T	XUB2BKXWM12T	XUB2AKXWM12T	XUN2AKXNM12T	XUM2AKXBM8T	
	<b>Thru-beam</b>  (T) (R)	30 m	PNP	cable	XUB2BPXNL2	XUB2APXNL2	17 m	XUB2BPXWL2	XUB2APXWL2	XUN2APXNL2	30 m	XUM2APXBL2
				connector 4P	XUB2BPXNM12	XUB2APXNM12		XUB2BPXWM12	XUB2APXWM12	XUN2APXNM12		XUM2APXBM8
				IO-Link	XUB2BPYNM12R	XUB2APYNM12R	XUB2BPYWM12R	XUB2APYWM12R	XUN2APYNM12			
			NPN	cable	XUB2BNXNL2	XUB2ANXNL2	XUB2BNXWL2	XUB2ANXWL2	XUN2ANXNL2	XUM2ANXBL2		
connector 4P				XUB2BNXNM12	XUB2ANXNM12	XUB2BNXWM12	XUB2ANXWM12	XUN2ANXNM12	XUM2ANXBM8			

(1) = Straight  
(2) = Angled

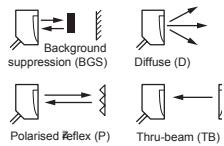
<b>Multimode</b>				Metal	Plastic	Plastic		
	DC3	PNP	cable	XUB0BPSNL2	XUB0APSNL2	XUM0APSA2		
			connector 4P	XUB0BPSNM12	XUB0APSNM12	XUM0APSAM8		
	NPN	cable	XUB0BNSNL2	XUB0ANSNL2	XUM0ANSAL2			
		connector 4P	XUB0BNSNM12	XUB0ANSNM12	XUM0ANSAM8			
Sensing distance				Background Sup: 0.12 m	Diffuse: 0.3 m	BGS: 0.1 m   D: 0.4 m		
Output function				NO or NC	Polarized reflex: 3 m	Thru-beam: 20 m   P: 3 m   TB: 10 m		
<b>Transmitter</b>				DC	cable	XUB0BKSNL2T	XUB0AKSNL2T	XUM0AKSAL2T
					connector 4P	XUB0BKSNM12T	XUB0AKSNM12T	XUM0AKSAM8T

**Other fixings**

XUB	Single bracket	with ball joint
	standard	
XUZA118 (stainless steel)		XUZA218 (plastic)
XUM	XUZA50	-
XUK	XUZA51	-
XUX	XUXZ2000	-

# Photo-electrics: XU Range

		Sensing distance		Compact 50x50 mm		Compact 92x71 mm						
	Diffuse	1 m	DC3	PNP	cable	XUK5APANL2	2.1 m	DC3	PNP	terminals	XUX5APANT16	
					connector 4P	XUK5APANM12				connector 4P	XUX5APANM12	
				NPN	cable	XUK5ANANL2				terminals	XUX5ANANT16	
					connector 4P	XUK5ANANM12				connector 4P	XUX5ANANM12	
				AC/DC	Relay	cable				XUK5ARCNL2	terminals	XUX5ARCNT16
Output function		NO		A		A						
		NC		B		B						
	Polarized Reflex	5 m	DC3	PNP	cable	XUK9APANL2	11 m	DC3	PNP	terminals	XUX9APANT16	
					connector 4P	XUK9APANM12				connector 4P	XUX9APANM12	
				NPN	cable	XUK9ANANL2				terminals	XUX9ANANT16	
					connector 4P	XUK9ANANM12				connector 4P	XUX9ANANM12	
				AC/DC	Relay	cable				XUK9ARCNL2	terminals	XUX9ARCNT16
Accessory: Reflector				XUZC50		XUZC50						
	Reflex	7 m	DC3	PNP	cable	XUK1APANL2	14 m	DC3	PNP	terminals	XUX1APANT16	
					connector 4P	XUK1APANM12				connector 4P	XUX1APANM12	
				NPN	cable	XUK1ANANL2				terminals	XUX1ANANT16	
					connector 4P	XUK1ANANM12				connector 4P	XUX1ANANM12	
				AC/DC	Relay	cable				XUK1ARCNL2	terminals	XUX1ARCNT16
Accessory: Reflector				XUZC50		XUZC50						
	Thru-beam	30 m	DC3	PNP	cable	XUK2APANL2R	40 m	DC3	PNP	terminals	XUX2APANT16R	
					connector 4P	XUK2APANM12R				connector 4P	XUX2APANM12R	
				NPN	cable	XUK2ANANL2R				terminals	XUX2ANANT16R	
					connector 4P	XUK2ANANM12R				connector 4P	XUX2ANANM12R	
				AC/DC	Relay	cable				XUK2AKSNL2T	terminals	XUX0AKSAT16T
						connector 4P				XUK2AKSNM12T	connector 4P	XUX0AKSAM12T
AC/DC	Relay	cable	XUK2ARCNL2R	terminals	XUX2ARCNT16R							
		cable	XUK2ARCNL2T	terminals	XUX0ARCTT16T							

Multimode		DC3 PNP/NPN		DC3 PNP/NPN			
	Background suppression (BGS) Diffuse (D) Polarised reflex (P) Thru-beam (TB)	AC/DC	Relay	cable	XUK0ARCTL2		
				connector 4P	XUK0AKSAM12		
		DC	Accessory: Transmitter	cable	XUK0AKSAL2	terminals	XUX0AKSAT16
				connector 4P	XUK0AKSAM12T	connector 4P	XUX0AKSAM12
AC/DC	Relay	cable	XUK0ARCTL2T	terminals	XUX0ARCTT16		
		Background Suppression: 0.28 m		Diffuse: 0.8 m			
		Polarized reflex: 4 m		Thru-beam: 30 m			
		DC		Background Suppression: 1.3 m			
				Diffuse: 2 m			
				Polarized reflex: 11 m			
				Thru-beam: 40 m			
				DC			
				terminals			
				connector 4P			
				terminals			
				connector 4P			
				terminals			
				connector 4P			
				terminals			
				connector 4P			
				terminals			
				connector 4P			
				terminals			

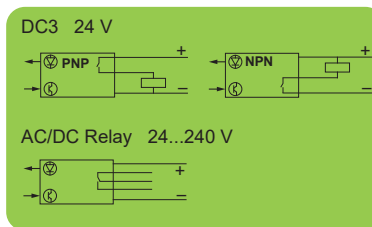

PUR pre wired connectors (female) (1)				Connectors (female)			
M12		straight	elbowed	straight	elbowed		
4 pin	2 m	XZCP1141L2	XZCP1241L2	XZCP1340L2	4 pin (2)	XZCC12FDM40B	XZCC12FCM40B
	5 m	XZCP1141L5	XZCP1241L5	XZCP1340L5	4 pin (3)	XZCC12FDP40B	XZCC12FCP40B
	10 m	XZCP1141L10	XZCP1241L10	XZCP1340L10			

(1) For a PVC cable, add the letter V after the P. Example: XZCPpppppp become XZCPVpppppp

# Photo-electrics applicative

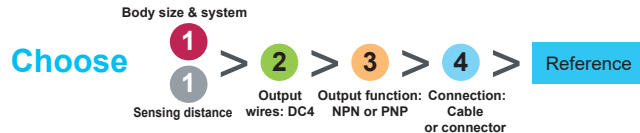

## Color sensors



Light type	Max. Sensing distance	Output type	Connection	Output function	Compact	Miniature	Sub-miniature
White	60 mm	DC5	PNP/NPN /IO-Link	M12 5-Pin	XUKCBSAYM12		
	150 mm				XUKCBLAYM12		
RGB LED	15 mm	DC4	PNP/NPN/IO-Link	M8 4-Pin		XUMRACAYM8	

## Color Mark Reader



RGB	15 mm	DC4	PNP/NPN/IO-Link	M8 4-Pin		XUMRAGAYM8	
				M12 4-Pin, 150 mm		XUMRAGAYP015	
White led	12 mm	DC4	PNP/NPN/IO-Link	M8 4-Pin		XUMRPGAYM8	
	15 mm			M8 4-Pin		XUMRAWAYM8	
Laser	250 mm	DC4	PNP/NPN/IO-Link	M12 4-Pin, 150 mm		XUMRAWAYP015	
				M8 4-Pin		XUM5ALAYM8	
				M12 4-Pin, 150 mm		XUM5ALAYP015	
				Cable, 2 m, 4-Wire		XUM5ALAYL2	

## Transparent



Red light	2000 mm	DC4	PNP/NPN/IO-Link	M8 4-Pin		XUMTARAYM8	
				M12 4-Pin, 150 mm		XUMTARAYP015	
				Cable, 2 m, 4-Wire		XUMTARAYL2	
Blue light	50 mm	DC4	PNP	M8 4-Pin		XUMTPRPM8	
				Accessory: Reflector		XUZC50	XUZC50
Blue light	100 mm	DC4	PNP	M8 4-Pin, 200 mm		XUT7ABXP02	
				Cable, 2 m, 4-Wire		XUT7ABPXL2	
Blue light	100 mm	DC4	PNP	M8 4-Pin		XUM7ABPM8	
				Cable, 2 m, 4-Wire		XUM7ABPXL2	
Blue light	100 mm	DC4	PNP/NPN/IO-Link	M8 4-Pin, 200 mm		XUT8ABAYP02	
				Cable, 2 m, 4-Wire		XUT8ABAYL2	
Blue light	200 mm	DC4	PNP/NPN/IO-Link	M8 4-Pin		XUM8ABAYM8	
				M12 4-Pin, 150 mm		XUM8ABAYP015	
Blue light	1200 mm	DC4	PNP	M12 4-Pin	XUK8ABPM12		

## Laser



Diffuse	250 mm	DC4	PNP/NPN/IO-Link	M8 4-Pin		XUM5ALAYM8	
				M12 4-Pin, 150 mm		XUM5ALAYP015	
				Cable, 2 m, 4-Wire		XUM5ALAYL2	
BGS	100 mm	DC4	PNP/NPN/IO-Link	M8 4-Pin, 200 mm		XUT8ALAYP02	
				Cable, 2 m, 4-Wire		XUT8ALAYL2	
BGS	150 mm	DC4	PNP/NPN/IO-Link	M8 4-Pin		XUM8ALAYM8	
				M12 4-Pin, 200 mm		XUM8ALAYP015	
Reflex	200 mm	DC4	PNP	M8 4-Pin		XUM8ALAYL2	
				M12 4-Pin, 200 mm		XUM8PLPM8	
Reflex	15 000 mm	DC4	PNP/NPN/IO-Link	M8 4-Pin		XUM9ALAYM8	
				M12 4-Pin, 200 mm		XUM9ALAYP015	
Reflex	12 000 mm	DC4	PNP/NPN/IO-Link	Cable, 2 m, 4-Wire		XUM9ALAYL2	
				M8 4-Pin		XUM9PLPM8	
Reflex	4000 mm	DC4	PNP	M8 4-Pin, 200 mm		XUT9ALXP02	
				Cable, 2 m, 4-Wire		XUT9ALPXL2	
		Accessory: Reflector High precision			XUZC50HP	XUZC50HP	



## BSG Blue Light



Fixed	50 mm	DC4	PNP	M8 4-Pin, 200 mm		XUT7ABXP02	
				Cable, 2 m, 4-Wire		XUT7ABPXL2	
Fixed	100 mm	DC4	PNP	M8 4-Pin		XUM7ABPM8	
				Cable, 2 m, 4-Wire		XUM7ABPXL2	
Teach	100 mm	DC4	PNP/NPN/IO-Link	M8 4-Pin, 200 mm		XUT8ABAYP02	
				Cable, 2 m, 4-Wire		XUT8ABAYL2	
Teach	200 mm	DC4	PNP/NPN/IO-Link	M8 4-Pin		XUM8ABAYM8	
				M12 4-Pin, 150 mm		XUM8ABAYP015	
Teach	1200 mm	DC4	PNP	M12 4-Pin	XUK8ABPM12		

# Accessories

## Reflectors

**XZ (... ) M8:**  
Connector M8 4 pin  

**XZ (... ) M12:**  
Connector M12 4 pin



XUZC24



XUZC80



XUZC50



XUZC50HP

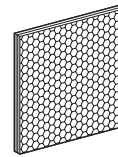

XUZC100

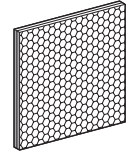

XUZC50CR

## Cabling XU

M12		PUR pre wired connectors (female) (1)		
4 pin		straight	elbowed	elbowed PNP LED
2 m	XZCP1141L2	XZCP1241L2	XZCP1340L2	
5 m	XZCP1141L5	XZCP1241L5	XZCP1340L5	
10 m	XZCP1141L10	XZCP1241L10	XZCP1340L10	

(1) For a PVC cable, add the letter V after the P.  
Example: XZCP1141L2 become XZCPV1141L2 for a PVC version

## Cabling XU

M8		PUR pre wired connectors (female) (1)	
4 pin		straight	elbowed
2 m	XZCP0941L2	XZCP1041L2	
5 m	XZCP0941L5	XZCP1041L5	
10 m	XZCP0941L10	XZCP1041L10	

(1) For a PVC cable, add the letter V after the P.  
Example: XZCP0941L2 become XZCPV0941L2



### XUZARM

Dovetail clamp  
Supplied with 2x M3 screws

Compatible with

XUM\*A\*AYM8  
XUM\*A\*AYP015  
XUM\*A\*AYL2  
XUM7ABPX\*\*



### XUZARS

Dovetail clamp  
Supplied with 2x M3 screws

Compatible with

XUT7ABPX\*\*  
XUT8A\*AY\*\*  
XUT9ABPX\*\*



### XUZARK

Dovetail clamp  
Supplied with 1x M3 screws

Compatible with

XUKCB\*AYM12  
XUK8ABPXM12



### XUZASS

Mounting bracket  
Supplied with 2x M3 screws

Compatible with

XUT7ABPX\*\*  
XUT8A\*AY\*\*  
XUT9ABPX\*\*

# Forks: XUV Range

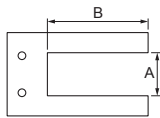

DC3	PNP	M8 3 pin	A: 50 mm / B: 60 mm	A: 80 mm / B: 60 mm	A: 120 mm / B: 120 mm	A: 180 mm / B: 120 mm
			NPN	M8 3 pin	XUVR0605P <sup>A</sup> NM8	XUVR0608P <sup>A</sup> NM8
			XUVR0605N <sup>A</sup> NM8	XUVR0608N <sup>A</sup> NM8	XUVR1212N <sup>A</sup> NM8	XUVR1218N <sup>A</sup> NM8
<b>Output function</b>		<b>NO</b>		<b>A</b>	<b>A</b>	<b>A</b>
		<b>NC</b>		<b>B</b>	<b>B</b>	<b>B</b>

DC3 24 V

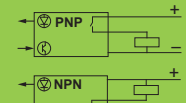

## Cabling XX & XUV

M8		PUR pre wired connectors (female) (1)			Connectors (female)			
3 pin		straight	elbowed	elbowed PNP LED	M12	straight	elbowed	
2 m	XZCP0566L2	XZCP0666L2			(2) 4 pin	XZCC12FDM40B	XZCC12FCM40B	
5 m	XZCP0566L5	XZCP0666L5			(3) 4 pin	XZCC12FDP40B	XZCC12FCP40B	
10 m	XZCP0566L10	XZCP0666L10			(2) Steel ring (3) Plastic ring			
4 pin		2 m	XZCP0941L2	XZCP1041L2				
		5 m	XZCP0941L5	XZCP1041L5				
		10 m	XZCP0941L10	XZCP1041L10				
M12					Connectors (male)			
4 pin		2 m	XZCP1141L2	XZCP1241L2	XZCP1340L2	M12	straight	elbowed
		5 m	XZCP1141L5	XZCP1241L5	XZCP1340L5	4 pin	XZCC12MDM40B	XZCC12MCM40B
		10 m	XZCP1141L10	XZCP1241L10	XZCP1340L10	5 pin	XZCC12MDM50B	XZCC12MCM50B

(1) For a PVC cable, add the letter V after the P. Example: XZCPpppppp become XZCPVpppppp

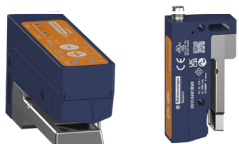

Push-Pull (PNP NO, NPN NC)

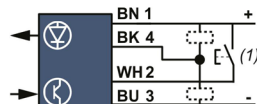

NPN (NO)

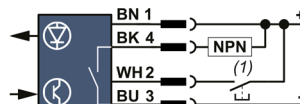

PNP (NO)

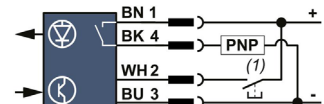

	Push-Pull (PNP NO, NPN NC)	NPN (NO)	PNP (NO)
M12	XUVU04M3BL02M12	XUVU04M3NL02M12	XUVU04M3PL02M12
Cable	XUVU04M3BL2	XUVU04M3NL2	XUVU04M3PL2
M8	XUVU04M3BM8	XUVU04M3NM8	XUVU04M3PM8

(1) WH 2 connected to (+) : External Teach-in

# Ultrasonics: XX Range

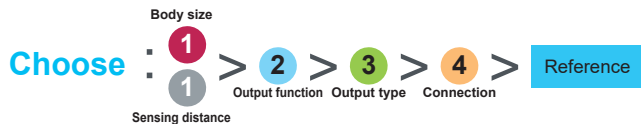

			M12		M18		M18 plastic (2)		M18 brass (2)		M18 stainless (2)		M18 metal	
Sensing distance			0.05 m	0.1 m	0.15 m	0.5 m Adjust. (1)	1 m Adjust. (1)	1 m Adjust. (1)	1 m Adjust. (1)	1 m Adjust. (1)	1 m Adjust. (1)	1 m Adjust. (1)	0.05 m	
Connectors/Cables			M8 4 pin	M8 3 pin	M12 4 pin	M12 4 pin	M12 5 pin	M12 5 pin	M12 5 pin	M12 5 pin	M12 5 pin	M12 4 pin		
NO	DC4	PNP/NPN	XX512A1KAM8		XX518A1KAM12									
	DC3	PNP		XX512A2PAM8		XX518A3PAM12							XXV18B1PAM12	
		NPN		XX512A2NAM8		XX518A3NAM12							XXV18B1NAM12	
NO or NC	DC3	PNP					XXS18P1PM12	XXS18B1PM12	XXS18S1PM12					
							XXA18P1PM12	XXA18B1PM12	XXA18S1PM12					
Analog		4...20 mA				XX918A3C2M12	XXS18P1AM12	XXS18B1AM12	XXS18S1AM12					
							XXA18P1AM12	XXA18B1AM12	XXA18S1AM12					
		0...10 V				XX918A3F1M12	XXS18P1VM12	XXS18B1VM12	XXS18S1VM12					
							XXA18P1VM12	XXA18B1VM12	XXA18S1VM12					

(1) Adjustable with XXZPB100

(2) Configurable with XXZBOX01 by software

S = straight A = angled

			M30 plastic (2)				M30 Brass (2)			M30 Stainless (2)		
Sensing distance			1 m Adjust. (1)	2 m Adjust. (1)	4 m Adjust. (1)	8 m Adjust. (3)	1 m Adjust. (1)	2 m Adjust. (1)	4 m Adjust. (1)	1 m Adjust. (1)	2 m Adjust. (1)	4 m Adjust. (1)
Connectors			M12 5-pin	M12 5-pin	M12 5-pin	M12 5-pin	M12 5-pin	M12 5-pin	M12 5-pin	M12 5-pin	M12 5-pin	M12 5-pin
NO or NC	DC3	PNP	XXS30P1PM12	XXS30P2PM12	XXS30P4PM12		XXS30B1PM12	XXS30B2PM12	XXS30B4PM12	XXS30S1PM12	XXS30S2PM12	XXS30S4PM12
			XXA30P1PM12	XXA30P2PM12			XXA30B1PM12	XXA30B2PM12		XXA30S1PM12	XXA30S2PM12	
	DC4	2 x PNP 2 x NPN				XXS30P8PM12						
							XXS30P8NPM12					
Analog	DC3	4...20mA	XXS30P1AM12	XXS30P2AM12	XXS30P4AM12		XXS30B1AM12	XXS30B2AM12	XXS30B4AM12	XXS30S1AM12	XXS30S2AM12	XXS30S4AM12
			XXA30P1AM12	XXA30P2AM12			XXA30B1AM12	XXA30B2AM12		XXA30S1AM12	XXA30S2AM12	
	DC3	0...10V	XXS30P1VM12	XXS30P2VM12	XXS30P4VM12		XXS30B1VM12	XXS30B2VM12	XXS30B4VM12	XXS30S1VM12	XXS30S2VM12	XXS30S4VM12
							XXA30B1VM12	XXA30B2VM12		XXA30S1VM12	XXA30S2VM12	
Analog + NO or NC	DC4	4...20 mA + PNP 0...10V + PNP				XXS30P8APM12						
						XXS30P8VPM12						

(1) Adjustable with XXZPB100

(2) Configurable with XXZBOX01 by software

(3) Push-button integrated on the product

S = straight A = angled

			Flat 7.6x19x33		Flat 16x30x74		Flat 60x30x18 + M18	
Sensing distance			0.1 m	0.25 m	0.5 m Adjust.	0.5 m Adjust.	0.5 m Adjust.	0.5 m Adjust.
Connectors			M12 4 pin	M12 4 pin	M12 4 pin	M12 4 pin	M12 4 pin	M12 4 pin
NO	DC3	PNP	XX7F1A2PAL01M12	XX7K1A2PAM12			XX7V1A1PAM12 (1)	
			NPN	XX7F1A2NAL01M12	XX7K1A2NAM12			XX7V1A1NAM12 (1)
Analog		4...20 mA 0...10 V					XX9V1A1C2M12 (1)	
							XX9V1A1F1M12 (1)	

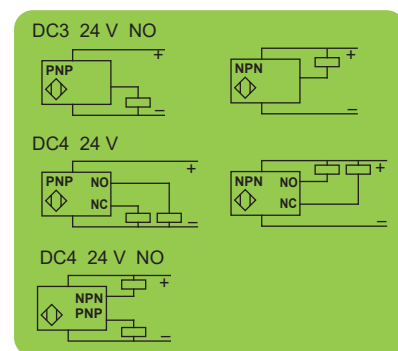

(1) Adjustable with XXZPB100



XUZ 2001	M12	XUZB2012				M12	XXZ12
XUZ 2003	M18	XUZB2003				M18	XUZA118
	M30	XUZB2030				M30	XXZ30
					For XX7K	XX7F	XXZ1933
					Flat		
					Cranked		
							Adjustable
							XXZPB100



# RFID Systems: XG Range

			
	Compact 40x40mm		
	Sensing distance 18-70mm		
	PNP output with 1 pulse	Modbus RTU	
	Blue body, connector on back	White body with remote lights, connector on back	Stand alone
<b>Panel mounting (1)</b>	XGCS491B201	XGCS49LB201	XGCS490B201

(1) compatible with ZB5AZ905 and XGSZCNFAC



			
	Compact 40x40mm	Compact 80x80mm	
	Sensing distance 18-70mm	Sensing distance 20-100mm	
	Modbus RTU		Modbus TCP & Ethernet/IP
	Blue body, connector and cable by side		
<b>Screw mounting</b>	XGCS4901201	XGCS8901201	XGCS850C201

<b>Accessories</b>		XGSZCNFAC	Set of configuration badges		XZCC12MDB50R	M12 connector	
		XGSZCNF01	Configuration badge		XZCPV11V2L2/5/10	M12 pre-wired connector	
		XGHB90E341	Pack of user's badges		XZCPV12V2L2/5/10	M12 pre-wired connector	
		XGHBPB3345	Key fob tag				

**Note:** For our complete range of sensor solutions, visit [www.tesensors.com](http://www.tesensors.com)

# IO-Link Master



IO-Link Master devices	Reference	Protocol	Supply voltage	Number of ports	Port size	Dimension (mm) (H x W x D)	Temperature range (°C) / Degree of protection	Product certification
	XZCOM8AM12EY	EtherNet/IP	18..31,2 VDC	8 class A	M12	200 x 60 x 32	-25..+70 / IP67	CE - UKCA (1)
	XZCOM8AM12PY	ProfiNet						

(1) cULus coming soon



Power cables	Reference	Type of connector	End fittings	Length (m)	
	XZCPK75DL2	Female	5-pin (1+FE)	2	1.5 mm <sup>2</sup>
	XZCPK75DL5			5	1.5 mm <sup>2</sup>
	XZCPK75CL2			2	1.5 mm <sup>2</sup>
	XZCPK75CL5			5	1.5 mm <sup>2</sup>
	XZCR25K25DL2	Male/Female	M12 5-pin/M12 5-pin	2	1.5 mm <sup>2</sup>
	XZCR25K25DL5			5	1.5 mm <sup>2</sup>
	XZCR26K26CL2			2	1.5 mm <sup>2</sup>
	XZCR26K26CL5			5	1.5 mm <sup>2</sup>

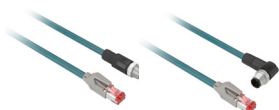

Communication cables	Reference	Type of connector	Length (m)
	XGSZ12E4503	M12 D-coded to RJ45, straight/straight	3
	XGSZ12E4510		10
	XGSZ22E4503	Jumper M12/RJ45, straight/elbowed	3
	XGSZ22E4510		10



T-connector	Reference	Type of connector	End fittings
	TCSCNT011M11F	1 Male/2 Female	M12 5-pin/M12 5-pin







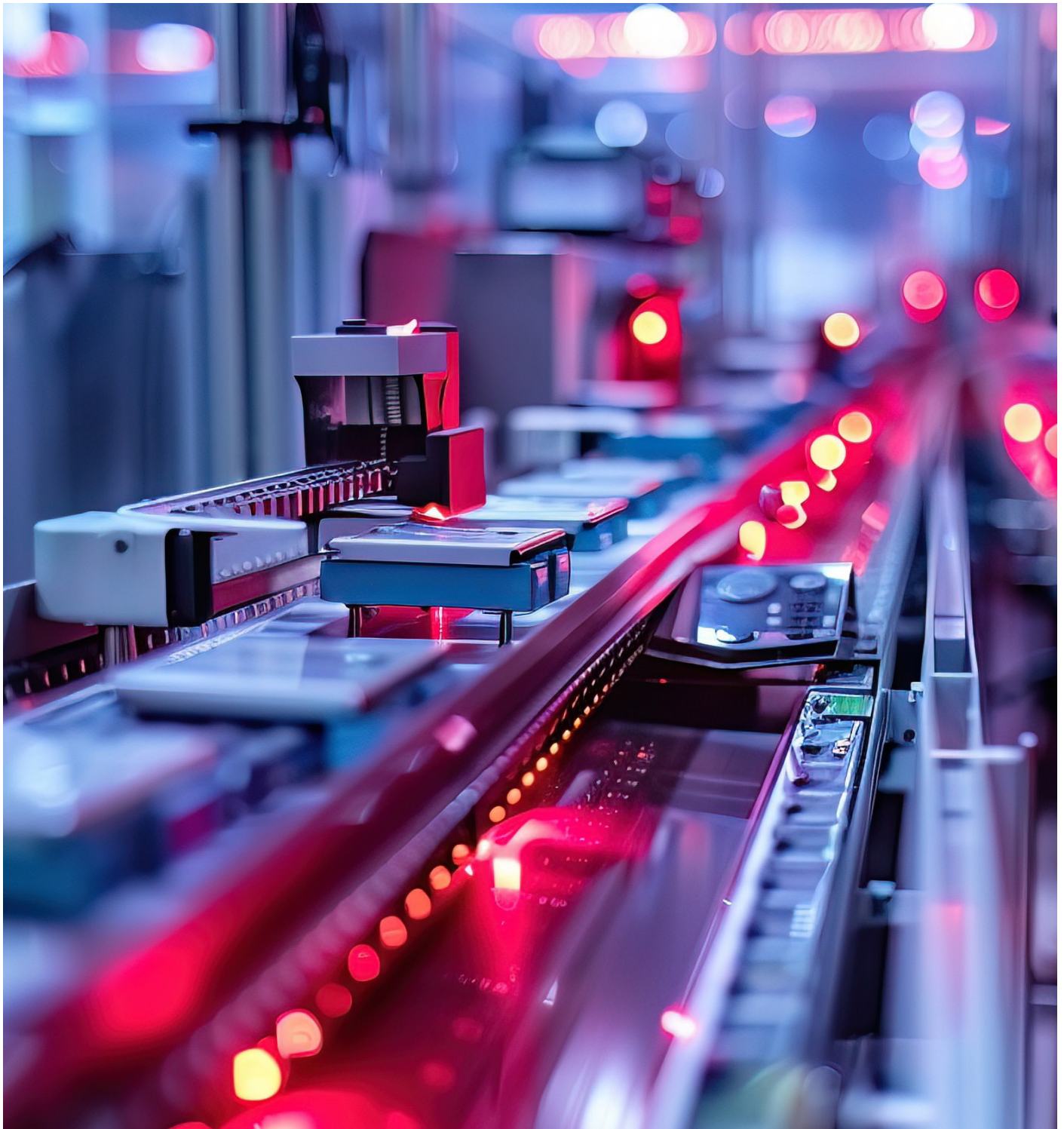

#### **TMSS France SAS**

Share capital: 366 931 214 euros  
2 Avenue Gambetta - Tour Eqho  
92400 Courbevoie  
908 125 255 RCS de Nanterre  
[www.telemecaniquesensors.com](http://www.telemecaniquesensors.com)

The information provided in this documentation contains general descriptions and/or technical characteristics of the performance of the products contained herein. As standards, specifications and design change from time to time, please ask for confirmation of the information given in this publication. Neither TMSS France nor any of its subsidiaries or other affiliated companies shall be responsible or liable for misuse of the information contained in this document.

Telemecanique™ Sensors is a trademark of Schneider Electric Industries SAS used under license by TMSS France. Any other brands or trademarks referred to in this document are property of TMSS France or, as the case may be, of its subsidiaries or other affiliated companies. All other brands are trademarks of their respective owners.

As standards, specifications and design change from time to time, please ask for confirmation of the information given in this publication

© 2024, TMSS France, All Rights Reserved

April 2025

TESELEA000087EN